

PUBLISHED BY

INTECH

open science | open minds

World's largest Science,
Technology & Medicine
Open Access book publisher



2800+
OPEN ACCESS BOOKS



97,000+
INTERNATIONAL
AUTHORS AND EDITORS



90+ MILLION
DOWNLOADS



BOOKS
DELIVERED TO
151 COUNTRIES

AUTHORS AMONG
TOP 1%
MOST CITED SCIENTIST



12.2%
AUTHORS AND EDITORS
FROM TOP 500 UNIVERSITIES



Selection of our books indexed in the
Book Citation Index in Web of Science™
Core Collection (BKCI)

Chapter from the book *Sustainable Energy - Technological Issues, Applications and Case Studies*

Downloaded from: <http://www.intechopen.com/books/sustainable-energy-technological-issues-applications-and-case-studies>

Interested in publishing with InTechOpen?
Contact us at book.department@intechopen.com

Clean Water from Clean Energy: Decentralised Drinking Water Production Using Wind Energy Powered Electrodialysis

Payam Malek, Helfrid M.A. Schulte-Herbrüggen and
Juan M. Ortiz

Additional information is available at the end of the chapter

<http://dx.doi.org/10.5772/65015>

Abstract

Supply of potable water requires energy and unfortunately most of the countries with minimal access to safe drinking water are also poor in terms of access to reliable energy grids. However, many of such regions have access to other sources of water (such as brackish and groundwater) that can be treated for producing drinking water if correct treatment systems are put in place. Moreover, many of the electrically remote areas are rich in terms of renewable energy (RE) resources (such as wind and solar) which can be potentially employed as the main source of energy for powering water purification systems. Therefore, development and implementation of off-grid RE powered contaminant removal systems, for producing freshwater from available resources (such as brackish and groundwater), can be considered as an effective and potentially sustainable solution for overcoming the drinking water scarcity issue in remote regions of developing countries. This chapter revises the state of the art related to desalination systems using electrodialysis technology powered by wind energy for decentralised water production.

Keywords: electrodialysis, renewable energy, drinking water, brackish water

“On the one hand, the world needs to provide adequate and sustainable access to more than 1.3 billion people who still lack electricity and to more than 700 million people who lack an improved water supply today [...], on the other hand, to keep up with the growing demand for both water and energy associated with population growth, rapid urbanization and economic development in a context of increased scarcity of natural resources, pollution, degraded ecosystems, climate change and regulation of greenhouse gas emissions..... In fact, there is an urgent need to address water and energy challenges in an integrated and

coordinated manner to ensure the sustainability of both water and energy services.” (Michel Jarraud, the Chair of UN-Water, January 2014)

1. Introduction

Energy and freshwater are undoubtedly the two inseparable and key resources for sustaining human life on earth. Supply of potable water requires energy and unfortunately most of the countries with minimal access to safe drinking water are also poor in terms of access to reliable energy grids. A worldwide map created by Vörösmarty et al. (**Figure 1A**) suggests high levels of exposure to water security risks for more than 80% of the world's population [1]. The term “incident” used in this map refers to exposure to a complex array of stress factors, sourced from both anthropogenic and natural sources, at a given location. Vörösmarty et al. argued that developing countries, and in particular the inhabitants of remote locations, suffer more severely from exposure to water security risks because they do not have the resources necessary to mitigate pressures on water supplies. However, in contrast, the developed countries often have the investment required to offset high stressor levels experienced by the human population, even though the actual pressure on water resources may be worse in these countries compared to the developing countries. Vörösmarty et al. backed up their arguments by publishing a second map, showing shifts in spatial patterns of threat to drinking water scarcity after accounting for water technology benefits (**Figure 1B**). According to the recent report by World Health Organisation [2, 3], around 768 million people lack access to freshwater sources, 83% of whom live in remote areas of developing countries. The problem of freshwater scarcity in remote regions is exacerbated by the fact that more than 84% of 1.3 billion people who have limited access to electricity, also live in these locations [4].

While the lack access to improved water supply is significantly acute in remote locations, many of such regions have access to other sources of water (such as brackish and groundwater) that can be treated for producing drinking water if correct treatment systems are put in place [5–9]. Moreover, many of the electrically remote areas are rich in terms of renewable energy (RE) resources (such as wind and solar) which can be potentially employed as the main source of energy for powering water purification systems [10–16]. Therefore, development and implementation of off-grid RE powered contaminant removal systems, for producing freshwater from available resources (such as brackish and groundwater), can be considered as an effective and potentially sustainable solution for overcoming the drinking water scarcity issue in remote regions of developing countries.

Trace inorganic ions are among the main sources of contamination in groundwater. The levels at which these contaminants exist in groundwater depends on the geological (e.g. leaching from surrounding rocks) or anthropogenic (e.g. industrial or domestic effluents) sources that these contaminants are discharged from [6, 17, 18]. Consumption of water containing trace inorganic contaminants, such as fluoride (F^-) and nitrate (NO_3^-), at concentrations above their recommended levels by drinking water guidelines may result in severe short and long-term physical and nervous disorders [19–24]. There are some other common inorganic ions in

brackish and groundwater which are of no significant health concern, but their excess concentrations in a water resource can make the water resource undrinkable (e.g. due to high salt content, taste issue or colour problem). Chloride (Cl^-) and sulphate (SO_4^{2-}) are in this category, for which only drinking water guideline limits for taste have been proposed [21]. Concerns over the toxicity and chemistry of inorganic contaminants in brackish and groundwater have resulted in increased interest in development of cost-effective desalination techniques in the recent years.

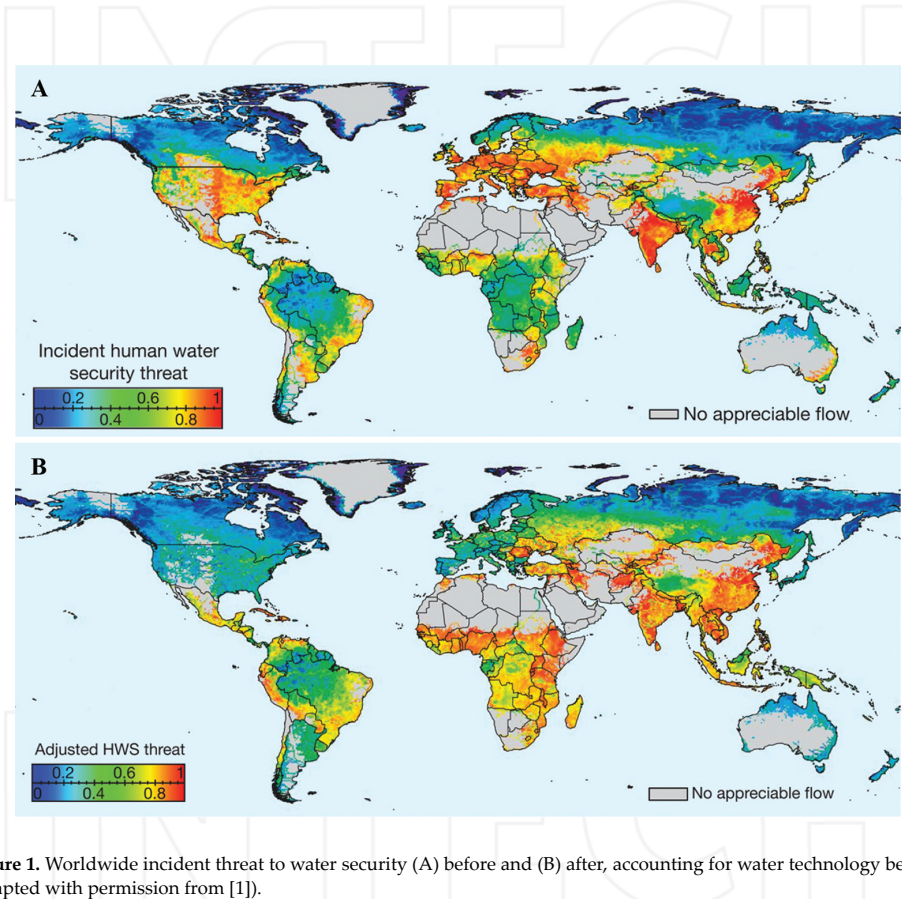

Figure 1. Worldwide incident threat to water security (A) before and (B) after, accounting for water technology benefits (adapted with permission from [1]).

2. Desalination system powered by renewable energy

Renewable energy (RE) powered membrane systems are promising technologies for brackish water desalination in remote regions due to their flexibility to be designed according to the number of inhabitants, available water supply and energy resources [10, 11, 16, 25–27].

Moreover, the application of membrane technologies for brackish water desalination was shown to be energetically less expensive (reverse osmosis (RO): 1.5–3.0 kWh/m³ and electro-dialysis (ED): 0.7–2.5 kWh/m³) compared to other alternative technologies such as multistage flash distillation (MSF: 19.5–27.3 kWh/m³), vapour-compression evaporation (VC: 7.0–16.2 kWh/m³) and multi-effect distillation (MED: 14.5–21.6 kWh/m³) methods [10, 12, 13]. Among several membrane systems, electro-dialysis (ED) has been established as a feasible desalination technique due to its simple ion recuperation, high ion selectivity and efficient ionic separation [28–31]. The high water recovery of 85–94%, the low maintenance required, the long lifetime of ion-exchange membranes due to their strong mechanical and chemical stability plus their tolerance for operation at high temperatures (up to 50°C) and extreme pH levels are features that make ED a particularly suitable desalination system for the use in remote regions with limited water resources. Moreover, the easy start up and shut down of ED makes this system suitable for direct coupling to fluctuating and intermittent sources of energy, such as renewable energies [30, 32, 33].

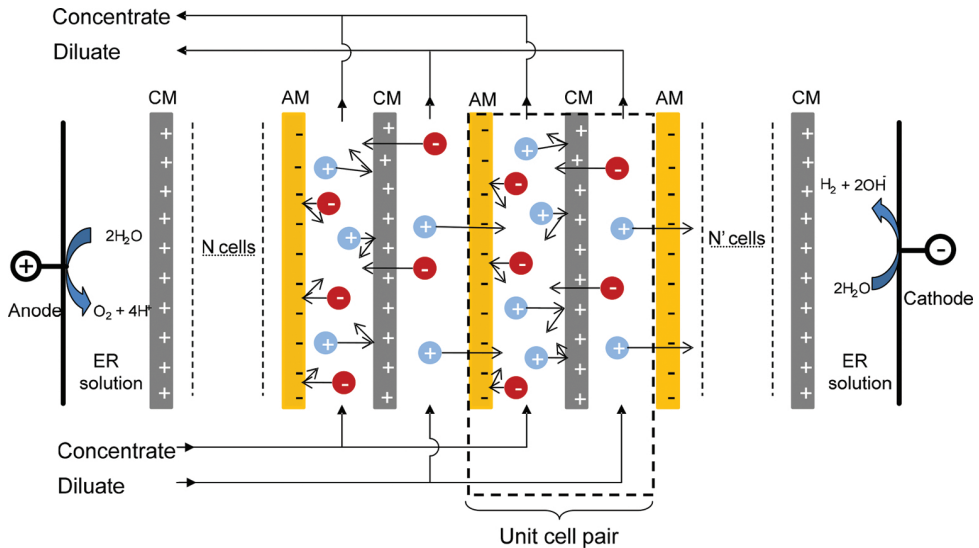

Figure 2. Schematic representation illustrating the ion transport principle across the ion-exchange membranes in an ED system (AM: anion exchange membrane, CM: cation exchange membrane, ER: electrode rinse).

ED is an electrically driven ion separation technique with a well-established use in many industrial applications such as brackish water desalination [34–36], wastewater treatment [28, 37–39], desalting of amino acids and organic solutions [40–43] and salt production [44–46]. An ED system consists of a number of alternately positioned cation and anion exchange membranes that are stacked together between two electrodes and are separated from each other by flow spacers [28, 30, 34, 47, 48]. The ion removal principle in an ED system is illustrated in **Figure 2**.

The salt solution is fed into the ED stack in a direction parallel to the ion-exchange membranes. Once a potential difference is applied across the electrodes, each ion in the solution starts to travel toward an oppositely charged electrode. While the passage of the ions is permitted through the oppositely charged ion-exchange membranes, their travel is terminated once they reach a similarly charged ion-exchange membrane. This results in the formation of a series of alternately positioned concentrate and diluate channels within the ED stack, through which the ion separation process takes place. This process continues in a batch circulating mode until the target salt concentration, which is often application dependent, is obtained in the diluate stream.

Most of the studies carried out on ED over the last 40 years focused on the conventional mode of operation where a constant voltage or current source is used for operating the membrane system [28, 30, 48–51]. The available studies on renewable energy powered ED technologies are very limited. Lundstrom [52] was the first to present the application of a renewable energy powered ED system for water purification purposes. He demonstrated the use of an off-grid photovoltaic (PV) powered ED system for brackish water desalination in remote regions in the south-western states of the USA where access to reliable electricity grid is minimal but the solar radiation is abundant. Later, Ishimaru [53] presented a study in which a series of PV cells were applied to charge a set of battery banks, which were subsequently used for powering an ED system to desalinate brackish water ($\text{TDS} \leq 1500 \text{ mg/L}$). The system showed reliable performance, producing freshwater in the range of $150\text{--}400 \text{ m}^3/\text{day}$, depending on the season and the solar irradiation, during the two-year period of testing. Although using deep cycle lead-acid batteries governs uninterrupted operation in indirect configuration of RE-membrane system coupling, they result in reduced robustness, lower efficiency, associated with continuous DC-AC-DC conversions and charging-discharging losses, plus increased capital and running costs [54–56]. The impacts of applying pulsed electric fields on minimising concentration polarisation [32, 57–60] and fouling mitigations [33, 61–65] in ED processes were investigated in a number of studies. The satisfactory operation of ED, despite having fluctuations in the energy source in these studies, suggests the possibility of coupling ED directly to fluctuating energy sources such as renewable energies (REs). Direct coupling of ED to an RE source can eliminate the need for having energy storage facilities (e.g. lead-acid batteries and flywheels); hence to minimise the aforementioned adverse behaviours linked with using such systems [54, 66]. More importantly the fact that ED operates with direct current (DC) [28, 30] makes this system particularly favourable for direct coupling to RE sources, as in such configuration no need for DC-AC conversion systems exists. AlMadani [67] was among the first who developed a directly coupled PV-ED system consisting of four hydraulic and two electric stages and demonstrated the impacts of process parameters, i.e. flow rate and temperature on removal of salt from groundwater. Ortiz et al. [68, 69], Uche et al. [70] and Cirez et al. [71] developed mathematical models describing the behaviour of different directly connected PV-ED systems. The models employed to predict the quality of the water product, the rate of desalination and specific energy consumption under given meteorological conditions and PV cell configurations. The results from these models showed very good corroboration with the experimental findings obtained in desalinating of real brackish water using the PV-ED systems.

3. Wind energy as suitable power source for desalination technology

Wind energy is particularly abundant on islands, coastal areas and mountain stations [72–76], and thus it is a favourable source of energy for desalination in such environments. As opposed to solar energy where availability is limited to the availability of sunlight during daytime, wind energy is readily available to be harvested over both day and night, assuming the wind system is well-sited [77]. This makes wind energy a superior alternative, in locations which are rich in terms of wind resources, compared to solar power for continuous powering of different processes, with less need for long-term energy storage. The use of wind energy for powering membrane-based desalination technologies was investigated by a number of researchers [14, 27, 78–84] and was proven to be economically feasible for some technologies including ultrafiltration (UF) and reverse osmosis (RO) [10, 14, 85] (Figure 3).

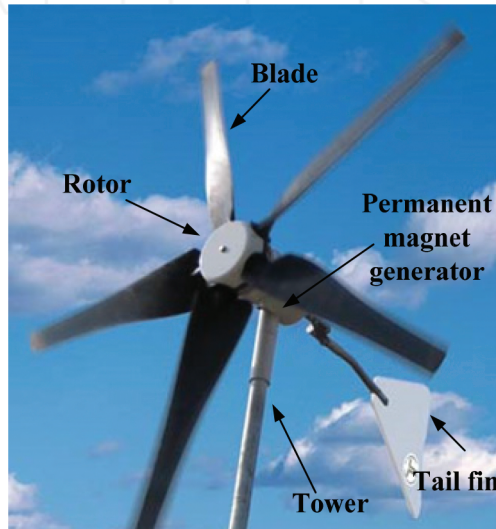

Figure 3. Main components of a small scale 1 kW Future Energy wind turbine (adapted with permission from [86]).

Comparisons made between the solar powered and wind powered membrane techniques show slightly lower specific energy consumption (SEC) for the wind powered membrane systems (e.g. 3.4 kWh/m³ for a wind-RO system versus 4 kWh/m³ for a PV-RO system, using the same RO module in both of the setups and desalinating from similar seawater feeds (32,800–34,300 mg/L TDS)) [80, 87–89]. The overall cost of desalination was also suggested to be lower when using wind energy as opposed to solar energy for powering the membrane systems [90]. In a review by El-Ghonemy [91], the cost of water production from brackish water desalination at the rate of 250 m³/day using PV-RO and wind-RO systems were reported to be 6.7 and 2.7 US\$/m³, respectively. Despite the advantages that wind energy has over solar energy, the number of wind-membrane systems developed and commercialised so far are

very limited compared to the solar powered membrane techniques. This can be partially attributed to the extreme fluctuations and intermittencies inherent to wind, making the harvesting of wind energy and coupling the wind turbines to the membrane systems technically very difficult. The latter is expected to be particularly challenging for pressure driven membrane systems (e.g. RO) that require constant power supply to perform satisfactory desalination [92, 93]. However, the extreme variations in the energy supply are expected to be less problematic for electrical driven techniques (e.g. ED) as their desalination performance has shown to be relatively robust despite energy fluctuations [33, 59–62, 65] (**Figure 4**).

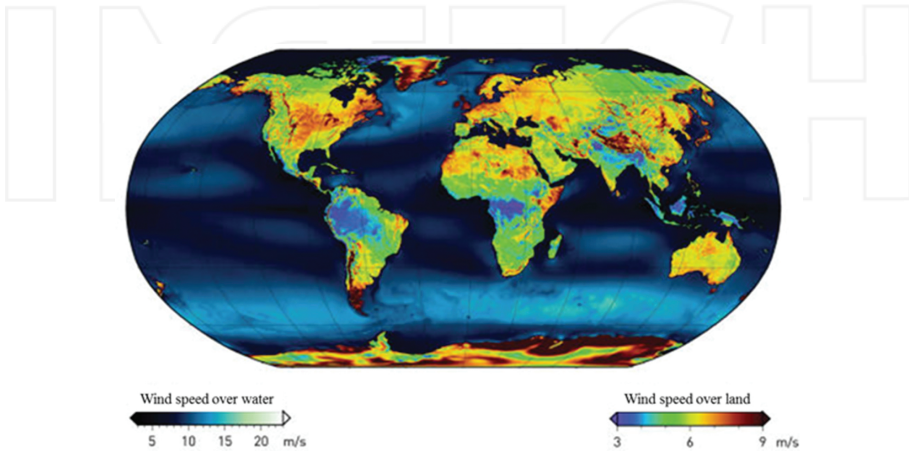

Figure 4. Worldwide average wind speed map, created based on wind speed measurements at the height of 80 m [94].

Up to date, no work on directly coupling ED with wind energy has been done. Veza et al. and Carta et al. [83, 95] studied a large-scale wind energy powered electro dialysis reversal (EDR) system, where a flywheel was employed as an intermediate temporary energy storage/energy buffering device between the wind turbines and the EDR stack (i.e. an indirect coupling of the renewable energy source with the membrane system). The aim was to develop automatic control electronics to allow the system to operate optimally, producing maximum volume of freshwater with minimum energy consumption. Although good quality drinking water was obtained using the wind energy powered membrane system, the field pilot nature of these tests did not allow drawing systematic and comprehensive understanding on how ion transport is influenced by wind speed fluctuations. Moreover, the fact that intermediate devices such as maximum power tracking and energy buffering systems (i.e. flywheel) were involved, it was difficult to specify the direct impacts of actual wind speed fluctuations on the ED performance.

The power produced from a permanent magnet generator-based wind turbine is principally dependent not only on the available wind condition but also on the resistance of the load directly connected to the wind system [96, 97]. Therefore, when connecting a wind turbine directly to an ED system, the power performance of the wind turbine is expected to vary with the change in the resistance of the ED stack during the desalination process. The latter is

expected to happen due to the change in the feed concentration or the flow rate of the diluate and concentrate streams. The change in the power performance of the wind turbine can result in further variations in the desalination characteristics of the membrane system and influence the energy expense of the desalination process. The potential behaviours to be seen from the membrane system in direct connection with a wind resource operating at steady wind speed conditions are yet unknown, hence they require systematic studies to be fully understood.

4. Direct desalination using electro dialysis powered by wind energy

As mentioned before, the main challenge in using a wind turbine for direct coupling with the membrane system, with no form of energy storage or energy regulator, is associated with the fluctuations and intermittenencies inherent to the wind resource. These fluctuations are a result of movements of large bulks of air over long periods (tens to hundreds of hours) and turbulence and gusts over short periods (seconds to a few minutes) [98–100]. The direct coupling of the wind system to the ED stack can inevitably result in fluctuations in the voltage and the current, ranging from mild fluctuations at low turbulence intensities to cycling on/off incidences occurring at extreme fluctuations. In order to establish solid understandings on how and in what extent the wind fluctuations affect the process of the ED system, it is necessary to carry out desalination studies using the membrane system over a range of wind speed fluctuations and intermittenencies.

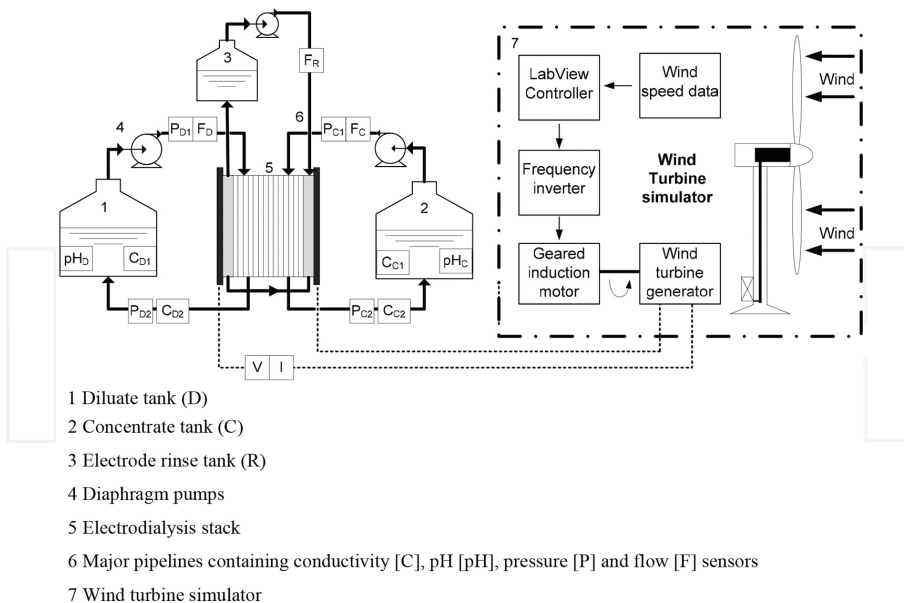

Figure 5. Schematic diagram of the wind-ED experimental setup used in [103].

The extremity and unpredictability of wind speed fluctuations [14, 77, 83, 98], and their significant variations from one location and season to another [73, 75, 76, 101, 102], restrict the choices of desalination technologies (e.g. RO, thermal or ED) that can handle such extreme energy variations, while exhibiting satisfactory desalination performance, when directly connected to wind turbine systems.

The direct connection of the wind turbine to a batch recirculating ED system (see **Figure 5**) was studied by Malek et al. [103] in a novel attempt in terms of coupling a wind turbine to a varying resistance load; since in all previous applications, wind turbines were mainly used to power constant resistance loads, these being either electricity grids or in smaller scales battery banks and supercapacitors [55, 98, 99, 104].

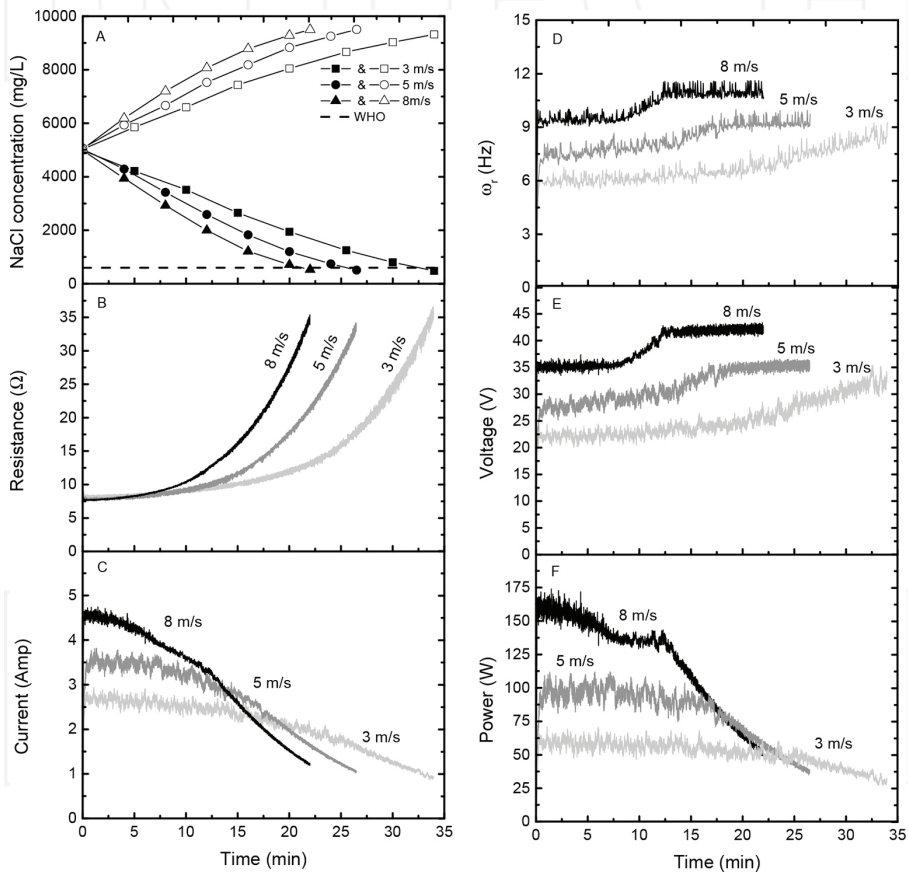

Figure 6. Steady state performance of the wind-ED system in desalinating from a feed of 5000 mg/L NaCl at constant wind speeds of 3, 5, and 8 m/s plotted as (A) NaCl concentration in both the diluate (solid symbols) and concentrate (hollow symbols) streams; (B) ED stack resistance; (C) current driven by the ED stack from the wind turbine; (D) angular velocity of the rotor (ω_r); (E) voltage; (F) wind-ED operating power (mode of operation: batch) [103].

Figure 6 shows the results obtained from systematic investigations of the wind-ED system performance under various wind speed conditions (from 2 to 10 m/s) with the aim of determining the impacts of low and high wind speeds on the desalination performance of ED by measuring clean water production and specific energy consumption (SEC) under constant wind speed conditions.

The results suggest that the desalination performance of the wind-ED system is mainly influenced by the wind speed when operating in the first power region, where no constraints have yet been posed on the voltage increase and, thus, the current transfer across the membranes varies primarily as a result of the wind speed. However, the dependency of the desalination performance on the wind speed diminishes significantly once the torque control system on the frequency inverter is activated to limit the voltage increase, as a result of which the power and correspondingly the desalination performance of the wind-membrane system begin to be principally controlled by the R_{stack} variations [103].

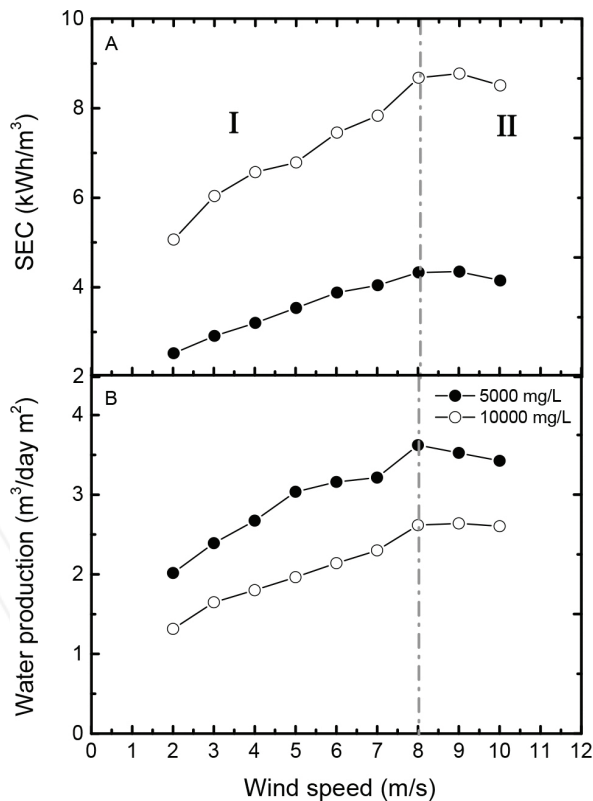

Figure 7. SEC (A) and water production (B) from desalinating feed solutions of 5000 and 10,000 mg/L NaCl over a range of constant wind speeds: 2–10 m/s at the flow rate of 7 L/min. I and II mark the two distinct behavioural regions for operating below and above the rated wind speeds, respectively (mode of operation: batch).

The ED system has been demonstrated to be an energetically robust system, performing effectively in the safe operating window when connected to renewable energy sources (wind power has the most extreme fluctuations among renewable energy alternatives). The main challenge in the direct coupling of the membrane system with a RE resource was seen to be not the size of the fluctuations but the impact of the power cycling off during long oscillation periods, which resulted in reduced water production and increased SECs (**Figure 7**).

5. Conclusions

Renewable energy powered membrane systems are considered as sustainable, energy efficient and reliable solutions for tackling the emerging issue of drinking water scarcity [10, 25, 27, 78]. Development and implementation of such technologies are of particular importance to remote arid areas of developing countries where people suffer the most from the lack of access to safe potable water. In *Malek et al.* [103], the direct coupling of wind energy with membranes was proposed as a solution to reduce the system costs as well as technical drawbacks associated with using intermediate energy storage systems such as acid-lead batteries, supercapacitors and flywheels.

5.1. Advantages of ED over other common desalination technologies for coupling with RE sources

Advantages for ED, in comparison with other common desalination technologies, for direct coupling to renewable energy (RE), can be deduced as specified in points 1–4, below:

1. Flexibility in operation with any amount of available energy

Common desalination technologies (i.e. RO, Thermal Vapour Compression, MED and MSF) [100, 105–107] often require a minimum level of energy to perform satisfactorily; which limits the employment of such technologies in direct coupling with RE systems for desalination in locations where sufficient RE may not be available throughout the year. To address this problem, some studies have proposed the use of energy storage systems [80, 82, 104]. However, energy storage systems increase both the capital and maintenance costs of the operation and also reduce the sustainability of the technology [55, 56]. Therefore, a better approach would be to use an energetically flexible technology, such as ED, that can operate more suitably in direct connection to RE sources with no need for energy storage devices. In terms of a safe operating window, the direct wind-membrane system produced good quality drinking water (<600 mg/L NaCl) over the wide range of wind speeds (2–10 m/s) and regardless of the initial feed concentration or the flow rate.

2. Robustness with respect to fluctuations and intermittencies in the RE source

Extreme fluctuations were shown to lead to reduced permeate quality and increased SEC in RO systems [100, 108, 109]. The use of temporary energy storage systems (e.g. supercapacitors) and energy buffering devices (e.g. flywheels) were proposed in some studies, as useful methods for governing uninterrupted operation of the desalination technologies powered

from fluctuating energy sources [66, 83, 95, 104]. However, as mentioned before, the use of energy storage systems is not favourable, as it leads to increased capital and maintenance costs as well as reduced sustainability. Using ED may again be a solution, as the SEC of this technique when directly powered from a wind resource was found to be relatively unaffected by fluctuations of any size (i.e. wind energy exhibits the largest fluctuations among the all REs). Therefore, ED can be introduced as an energetically robust desalination system, suitable for direct coupling with renewable energy sources.

3. Mechanical solidity against energy fluctuations

Energy fluctuations in some studies were suggested to cause reduction in the lifetime and efficiency of the pumps [110, 111] and produce fatigue damage to the membrane polymers [80]. Such problems can be significantly detrimental to the long-term operation of pressure driven technologies such as reverse osmosis. However for ED, since it is not a pressure driven process the ion-exchange membranes are expected to remain relatively unaffected by the fluctuations. Moreover, if the pumps of ED are powered by renewable energies, because they often operate at very low pressures, they are expected to be much less influenced by the fluctuations in the RE resource, compared to the pumps in a RO system.

4. Specific energy consumption (SEC)

SEC of the ED process increased with the wind speed, from 2.52 at 2 m/s to 4.15 kWh/m³ at 10 m/s, when desalinated a feed solution of 5000 mg/L NaCl. The SEC values obtained were within the range reported in the literature for the ED process (2.64 and 5.5 kWh/m³) when desalinating brackish waters containing 2500–5000 mg/L total dissolved solids (TDS) [10, 112]. These SEC values were also very close to the minimum SEC reported by Park et al. (2.8 kWh/m³) for desalinating feeds of 2500–5500 mg/L TDS, using a directly powered wind-reverse osmosis system (wind-RO) [14]. A comparison between the obtained SEC values in direct wind-energy electro dialysis and the ones reported in the literature for other common desalination techniques suggests that ED is energetically competitive with RO (1.5–3.0 kWh/m³) and significantly more efficient than common distillation-based desalination systems (i.e. MSF: 19.5–27.3 kWh/m³, MED: 14.5–21.6 kWh/m³ and VC: 7.0–16.2 kWh/m³) for treating brackish groundwater containing 5000 mg/L or lower TDS [10, 11, 113, 114].

The overall conclusion is that the wind-ED system is an energetically robust and technically reliable off-grid desalination method for the use in brackish water desalination applications in water stressed remote regions in both developing and developed countries.

Acknowledgements

P. Malek was supported by the University of Edinburgh Diversity in Engineering Scholarship. The University of Edinburgh and Heriot Watt University are acknowledged for providing support and expert facilities. Juan M. Ortiz was supported by the European Union through the MiDes Project. This project has received funding from the European Union's Horizon 2020 research and innovation programme under grant agreement No 685793.

Author details

Payam Malek¹, Helfrid M.A. Schulte-Herbrüggen^{1,2} and Juan M. Ortiz^{3*}

*Address all correspondence to: juanma.ortiz@imdea.org

1 School of Engineering, The University of Edinburgh, Edinburgh, United Kingdom

2 KTH Royal Institute of Technology, SEED, Stockholm, Sweden

3 IMDEA Water Institute, Madrid, Spain

References

- [1] Vörösmarty, C.J., et al., *Global threats to human water security and river biodiversity*. Nature, 2010. 467(7315): p. 555–561.
- [2] WHO, *Water Quality and Health Strategy 2013–2020*, 2013, World Health Organisation: Geneva.
- [3] WHO/UNICEF, *Progress on Sanitation and Drinking-Water: 2013 Update*, 2013, WHO/UNICEF Joint Monitoring Programme for Water Supply and Sanitation: WHO, Geneva and UNICEF, New York.
- [4] IEA, *World Energy Outlook 2011*. 2011, International Energy Agency: Paris, France.
- [5] Mahmoudi, H., et al., Assessment of wind energy to power solar brackish water greenhouse desalination units: a case study from Algeria. *Renewable and Sustainable Energy Reviews*, 2009. 13(8): p. 2149–2155.
- [6] Rossiter, H.M.A., et al., *Chemical drinking water quality in Ghana: Water costs and scope for advanced treatment*. *Science of the Total Environment*, 2010. 408(11): p. 2378–2386.
- [7] Schäfer, A.I., et al., Physico-chemical water quality in Ghana: prospects for water supply technology implementation. *Desalination*, 2009. 248(1–3): p. 193–203.
- [8] Ayoub, J. and R. Alward, Water requirements and remote arid areas: the need for small-scale desalination. *Desalination*, 1996. 107(2): p. 131–147.
- [9] Raucher, R., et al., *Guidelines for Implementing Seawater and Brackish Water Desalination Facilities*, 2010, Water Research Foundation and Arsenic Water Technology.
- [10] Al-Karaghoul, A. and L.L. Kazmerski, Energy consumption and water production cost of conventional and renewable-energy-powered desalination processes. *Renewable and Sustainable Energy Reviews*, 2013. 24: p. 343–356.

- [11] Al-Karaghoul, A., D. Renne, and L.L. Kazmerski, *Solar and wind opportunities for water desalination in the Arab regions*. Renewable & Sustainable Energy Reviews, 2009. 13(9): p. 2397–2407.
- [12] Gude, V.G., N. Nirmalakhandan, and S. Deng, *Renewable and sustainable approaches for desalination*. Renewable and Sustainable Energy Reviews, 2010. 14(9): p. 2641–2654.
- [13] Shatat, M., M. Worall, and S. Riffat, *Opportunities for solar water desalination worldwide: review*. Sustainable Cities and Society, 2013. 9: p. 67–80.
- [14] Park, G.L., A.I. Schäfer, and B.S. Richards, Renewable energy powered membrane technology: the effect of wind speed fluctuations on the performance of a wind-powered membrane system for brackish water desalination. Journal of Membrane Science, 2011. 370(1–2): p. 34–44.
- [15] Richards, L.A., B.S. Richards, and A.I. Schäfer, Renewable energy powered membrane technology: salt and inorganic contaminant removal by nanofiltration/reverse osmosis. Journal of Membrane Science, 2011. 369(1–2): p. 188–195.
- [16] Schäfer, A. Broeckmann, and Richards, *Renewable energy powered membrane technology. 1. Development and characterization of a photovoltaic hybrid membrane system*. Environmental Science & Technology, 2006. 41(3): p. 998–1003.
- [17] Bassett, R.L., et al., *Identification of groundwater solute sources using boron isotopic composition*. Environmental Science & Technology, 1995. 29(12): p. 2915–2922.
- [18] Favre-Réguillon, A., et al., *Selective removal of dissolved uranium in drinking water by nanofiltration*. Water Research, 2008. 42(4–5): p. 1160–1166.
- [19] Ergun, E., et al., *Electrodialytic removal of fluoride from water: effects of process parameters and accompanying anions*. Separation and Purification Technology, 2008. 64(2): p. 147–153.
- [20] European Union, *Council Directive 98/83/EC of 3 November 1998 on the quality of water intended for human consumption*. Official Journal L 330, 1998: p. 32–54.
- [21] WHO, *Guidelines for Drinking-water Quality*. Geneva, Switzerland 2011.
- [22] Tamer, M.N., et al., *Osteosclerosis due to endemic fluorosis*. Science of The Total Environment, 2007. 373(1): p. 43–48.
- [23] El Midaoui, A., et al., *Optimization of nitrate removal operation from ground water by electro dialysis*. Separation and Purification Technology, 2002. 29(3): p. 235–244.
- [24] Amini, M., et al., *Statistical modeling of global geogenic fluoride contamination in groundwaters*. Environmental Science & Technology, 2008. 42(10): p. 3662–3668.
- [25] El-Ghonemy, A.M.K., *Water desalination systems powered by renewable energy sources: review*. Renewable and Sustainable Energy Reviews, 2012. 16(3): p. 1537–1556.

- [26] Peñate, B., et al., *Design and testing of an isolated commercial EDR plant driven by solar photovoltaic energy*. *Desalination and Water Treatment*, 2012. 51(4–6): p. 1254–1264.
- [27] Subiela, V.J., et al., *Canary Islands Institute of Technology (ITC) experiences in desalination with renewable energies (1996–2008)*. *Desalination & Water Treatment*, 2009. 7(1–3): p. 220–235.
- [28] Xu, T. and C. Huang, *Electrodialysis-based separation technologies: a critical review*. *AIChE Journal*, 2008. 54(12): p. 3147–3159.
- [29] Van der Bruggen, B., et al., *Electrodialysis and nanofiltration of surface water for subsequent use as infiltration water*. *Water Research*, 2003. 37(16): p. 3867–3874.
- [30] Strathmann, H., *Ion-Exchange Membrane Separation Processes*. *Membrane Science and Technology*. Vol. 9. 2004: Elsevier. 348.
- [31] Valero, F., A. Barceló, and R. Arbós, *Electrodialysis technology—theory and applications*, in *Desalination, Trends and Technologies*, M. Schorr, Editor 2011: Rijeka, Croatia InTech.
- [32] Karlin, Y.V. and V.N. Kropotov, *Electrodialysis separation of Na⁺ and Ca⁺ in a pulsed current mode*. *Russian Journal of Electrochemistry*, 1995. 31(5): p. 517–521.
- [33] Ruiz, B., et al., *Application of relaxation periods during electrodialysis of a casein solution: Impact on anion-exchange membrane fouling*. *Journal of Membrane Science*, 2007. 287(1): p. 41–50.
- [34] Lee, H.-J., et al., *Designing of an electrodialysis desalination plant*. *Desalination*, 2002. 142(3): p. 267–286.
- [35] Demircioglu, M., et al., *Demineralization by electrodialysis (ED)—separation performance and cost comparison for monovalent salts*. *Desalination*, 2003. 153(1–3): p. 329–333.
- [36] Tanaka, Y., *Mass transport and energy consumption in ion-exchange membrane electrodialysis of seawater*. *Journal of Membrane Science*, 2003. 215(1–2): p. 265–279.
- [37] Bernardes, A.M., et al., *Electrochemistry as a clean technology for the treatment of effluents: the application of electrodialysis*. *Metal Finishing*, 2000. 98(11): p. 52–114.
- [38] Goodman, N.B., et al., *A feasibility study of municipal wastewater desalination using electrodialysis reversal to provide recycled water for horticultural irrigation*. *Desalination*, 2013. 317: p. 77–83.
- [39] Korngold, E., K. Kock, and H. Strathmann, *Electrodialysis in advanced waste water treatment*. *Desalination*, 1977. 24(1–3): p. 129–139.
- [40] Boniardi, N., et al., *Lactic acid production by electrodialysis. Part I: experimental tests*. *Journal of Applied Electrochemistry*, 1997. 27(2): p. 125–133.
- [41] Boniardi, N., et al., *Lactic acid production by electrodialysis. Part II: modelling*. *Journal of Applied Electrochemistry*, 1997. 27(2): p. 135–145.

- [42] Montiel, V., et al., *Recovery by means of electrodialysis of an aromatic amino acid from a solution with a high concentration of sulphates and phosphates*. Journal of Membrane Science, 1998. 140(2): p. 243–250.
- [43] Poquis, J.A., et al., *Partial electro-neutralisation of d- α -p-hydroxyphenylglycine in sulphuric acid medium*. Journal of Membrane Science, 2000. 170(2): p. 225–233.
- [44] Turek, M., *Dual-purpose desalination-salt production electrodialysis*. Desalination, 2003. 153(1–3): p. 377–381.
- [45] Yamamoto, M., et al., *A new electro-dialyzer technique for the salt production by ion-exchange membrane*, in Eighth World Salt Symposium, May 7–11 2000, The Hague: Netherlands. p. 1647–1652.
- [46] Takashima, K., et al., *The seawater pretreatment facilities for electrodialysis at Sanuki Salt Manufacturing Co., Ltd.*, in Eighth World Salt Symposium May 7–11 2000, The Hague: Netherlands. p. 1641–1646.
- [47] Eigenberger, G., H. Strathmann, and A. Grabovskiy, *Membrane assembly, electrodialysis device and method for continuous electrodialytic desalination*, 2005, Germany WO 2005/009596 Int. Cl. A1, B01D 61/44.
- [48] Strathmann, H., *Electrodialysis, a mature technology with a multitude of new applications*. Desalination, 2010. 264(3): p. 268–288.
- [49] Krol, J.J., *Monopolar and bipolar ion-exchange membranes: mass transport limitations*, 1997, University of Twente: Enschede, The Netherlands.
- [50] Ben Sik Ali, M., B. Hamrouni, and M. Dhabbi, *Electrodialytic defluoridation of brackish water: effect of process parameters and water characteristics*. CLEAN—Soil, Air, Water, 2010. 38(7): p. 623–629.
- [51] Gnusin, N. and O. Demina, *Modeling of transfer in electrodialysis systems*. Theoretical Foundations of Chemical Engineering, 2006. 40(1): p. 27–31.
- [52] Lundstrom, J.E., *Water desalting by solar powered electrodialysis*. Desalination, 1979. 31(1–3): p. 469–488.
- [53] Ishimaru, N., *Solar photovoltaic desalination of brackish-water in remote areas by electrodialysis*. Desalination, 1994. 98(1–3): p. 485–493.
- [54] Hadjipaschalis, I., A. Poullikkas, and V. Efthimiou, *Overview of current and future energy storage technologies for electric power applications*. Renewable and Sustainable Energy Reviews, 2009. 13(6–7): p. 1513–1522.
- [55] Beaudin, M., et al., *Energy storage for mitigating the variability of renewable electricity sources: an updated review*. Energy for Sustainable Development, 2010. 14(4): p. 302–314.
- [56] Kousksou, T., et al., *Energy storage: applications and challenges*. Solar Energy Materials and Solar Cells, 2014. 120, Part A: p. 59–80.

- [57] Dukhin, S.S. and N.A. Mishchuk, *Intensification of electrodialysis based on electroosmosis of the second kind*. Journal of Membrane Science, 1993. 79(2–3): p. 199–210.
- [58] Mishchuk, N.A., *Perspectives of the electrodialysis intensification*. Desalination, 1998. 117(1–3): p. 283–295.
- [59] Mishchuk, N.A., L.K. Koopal, and F. Gonzalez-Caballero, *Intensification of electrodialysis by applying a non-stationary electric field*. Colloids and Surfaces A: Physicochemical and Engineering Aspects, 2001. 176(2–3): p. 195–212.
- [60] Mishchuk, N.A., S.V. Verbich, and F. Gonzales-Caballero, *Concentration polarization and specific selectivity of membranes in pulse mode*. Colloid Journal, 2001. 63(5): p. 586–594.
- [61] Lee, H.-J. and S.-H. Moon, *Enhancement of electrodialysis performances using pulsing electric fields during extended period operation*. Journal of Colloid and Interface Science, 2005. 287(2): p. 597–603.
- [62] Lee, H.-J., S.-H. Moon, and S.-P. Tsai, *Effects of pulsed electric fields on membrane fouling in electrodialysis of NaCl solution containing humate*. Separation and Purification Technology, 2002. 27(2): p. 89–95.
- [63] Casademont, C., et al., *Electrodialysis of model salt solution containing whey proteins: enhancement by pulsed electric field and modified cell configuration*. Journal of Membrane Science, 2009. 328(1–2): p. 238–245.
- [64] Cifuentes-Araya, N., G. Pourcelly, and L. Bazinet, *Impact of pulsed electric field on electrodialysis process performance and membrane fouling during consecutive demineralization of a model salt solution containing a high magnesium/calcium ratio*. Journal of Colloid and Interface Science, 2011. 361(1): p. 79–89.
- [65] Cifuentes-Araya, N., G. Pourcelly, and L. Bazinet, *Multistep mineral fouling growth on a cation-exchange membrane ruled by gradual sieving effects of magnesium and carbonate ions and its delay by pulsed modes of electrodialysis*. Journal of Colloid and Interface Science, 2012. 372(1): p. 217–230.
- [66] Subiela, V.J., J.A. Carta, and J. González, *The SDAWES project: lessons learnt from an innovative project*. Desalination, 2004. 168: p. 39–47.
- [67] AlMadani, H.M.N., *Water desalination by solar powered electrodialysis process*. Renewable Energy, 2003. 28(12): p. 1915–1924.
- [68] Ortiz, J.M., et al., *Photovoltaic electrodialysis system for brackish water desalination: modeling of global process*. Journal of Membrane Science, 2006. 274(1–2): p. 138–149.
- [69] Ortiz, J.M., et al., *Desalination of underground brackish waters using an electrodialysis system powered directly by photovoltaic energy*. Solar Energy Materials and Solar Cells, 2008. 92(12): p. 1677–1688.
- [70] Uche, J., et al., *On-grid and off-grid batch-ED (electrodialysis) process: simulation and experimental tests*. Energy, 2013. 57: p. 44–54.

- [71] Cirez, F., et al., *Batch ED fed by a PV unit: a reliable, flexible, and sustainable integration*. Desalination and Water Treatment, 2013. 51(4–6): p. 673–685.
- [72] Maatallah, T., et al., *Wind power assessment and evaluation of electricity generation in the Gulf of Tunis, Tunisia*. Sustainable Cities and Society, 2013. 6: p. 1–10.
- [73] Chang, T.J. and Y.L. Tu, *Evaluation of monthly capacity factor of WECS using chronological and probabilistic wind speed data: a case study of Taiwan*. Renewable Energy, 2007. 32(12): p. 1999–2010.
- [74] Jowder, F.A.L., *Wind power analysis and site matching of wind turbine generators in Kingdom of Bahrain*. Applied Energy, 2009. 86(4): p. 538–545.
- [75] de Araujo Lima, L. and C.R. Bezerra Filho, *Wind energy assessment and wind farm simulation in Triunfo—Pernambuco, Brazil*. Renewable Energy, 2010. 35(12): p. 2705–2713.
- [76] Ahmed Shata, A.S. and R. Hanitsch, *Electricity generation and wind potential assessment at Hurghada, Egypt*. Renewable Energy, 2008. 33(1): p. 141–148.
- [77] Peinke, J., et al., *Turbulence, a challenging problem for wind energy*. Physica A: Statistical Mechanics and its Applications, 2004. 338(1–2): p. 187–193.
- [78] Charcosset, C., *A review of membrane processes and renewable energies for desalination*. Desalination, 2009. 245(1–3): p. 214–231.
- [79] Dehmas, D.A., et al., *On the use of wind energy to power reverse osmosis desalination plant: a case study from Ténès (Algeria)*. Renewable and Sustainable Energy Reviews, 2011. 15(2): p. 956–963.
- [80] Infield, D., *Performance analysis of a small wind powered reverse osmosis plant*. Solar Energy, 1997. 61(6): p. 415–421.
- [81] Lindemann, J.H., *Wind and solar powered seawater desalination applied solutions for the Mediterranean, the Middle East and the Gulf countries*. Desalination, 2004. 168: p. 73–80.
- [82] Peñate, B., et al., *Assessment of a stand-alone gradual capacity reverse osmosis desalination plant to adapt to wind power availability: a case study*. Energy, 2011. 36(7): p. 4372–4384.
- [83] Veza, J., B. Peñate, and F. Castellano, *Electrodialysis desalination designed for off-grid wind energy*. Desalination, 2004. 160(3): p. 211–221.
- [84] Veza, J.M., B. Peñate, and F. Castellano, *Electrodialysis desalination designed for wind energy (on-grid tests)*. Desalination, 2001. 141(1): p. 53–61.
- [85] Garcia-Rodriguez, L., *Renewable energy applications in desalination: state of the art*. Solar Energy, 2003. 75(5): p. 381–393.
- [86] FutureEnergy. <http://www.futureenergy.co.uk/>. 2010 [cited 2014 01 May]; Available from: <http://www.futureenergy.co.uk/>.

- [87] Miranda, M.S. and D. Infield, *A wind-powered seawater reverse-osmosis system without batteries*. *Desalination*, 2003. 153(1–3): p. 9–16.
- [88] Thomson, M. and D. Infield, *A photovoltaic-powered seawater reverse-osmosis system without batteries*. *Desalination*, 2003. 153(1–3): p. 1–8.
- [89] Thomson, M. and D. Infield, *Laboratory demonstration of a photovoltaic-powered seawater reverse-osmosis system without batteries*. *Desalination*, 2005. 183(1–3): p. 105–111.
- [90] Gilau, A.M. and M.J. Small, *Designing cost-effective seawater reverse osmosis system under optimal energy options*. *Renewable Energy*, 2008. 33(4): p. 617–630.
- [91] El-Ghonemy, A.M.K., *Future sustainable water desalination technologies for the Saudi Arabia: a review*. *Renewable and Sustainable Energy Reviews*, 2012. 16(9): p. 6566–6597.
- [92] Souari, L. and M. Hassairi, *Sea water desalination by reverse osmosis: the true needs for energy*. *Desalination*, 2007. 206(1–3): p. 465–473.
- [93] Petersen, G., et al., *Wind and solar powered reverse osmosis desalination units—design, start up, operating experience*. *Desalination*, 1981. 39: p. 125–135.
- [94] Farris, A. *Wind*. 2012 [cited 2014 30 April]; Available from: <http://www.energybc.ca/profiles/wind.html>.
- [95] Carta, J., J. González, and V. Subiela, *The SDAWES project: an ambitious R&D prototype for wind-powered desalination*. *Desalination*, 2004. 161(1): p. 33–48.
- [96] Dubois, M.R.J., *Optimized Permanent Magnet Generator Topologies for Direct-drive Wind Turbines*, 2004, Delft University: Les Imprimeries ABC Inc., Lévis, Canada. p. 237.
- [97] Stander, J.N., G. Venter, and M.J. Kamper, *Review of direct-drive radial flux wind turbine generator mechanical design*. *Wind Energy*, 2012. 15(3): p. 459–472.
- [98] Burton, T., et al., *Wind Energy Handbook*. West Sussex, England 2001: John Wiley & Sons Ltd.
- [99] Manwell, J.F., *Wind Energy Explained: Theory, Design and Application*. West Sussex, England 2002: John Wiley & Sons Ltd.
- [100] Park, G.L., *Wind-powered membrane desalination of brackish water*, in School of Engineering and Physical Sciences, 2012, Heriot-Watt University: Edinburgh, UK.
- [101] Ackermann, T. and L. Söder, *An overview of wind energy-status 2002*. *Renewable and Sustainable Energy Reviews*, 2002. 6(1–2): p. 67–127.
- [102] Justus, C.G., W.R. Hargraves, and A. Yalcin, *Nationwide assessment of potential output from wind-powered generators*. *Journal of Applied Meteorology*, 1976. 15(7): p. 673–678.
- [103] Malek, P., Ortiz, J.M., Schulte-Herbrüggen, H.M.A., *Decentralized desalination of brackish water using an electrodialysis system directly powered by wind energy*, *Desalination*, 2016, 377, 54–64.

- [104] Park, G.L., A.I. Schäfer, and B.S. Richards, *Renewable energy-powered membrane technology: supercapacitors for buffering resource fluctuations in a wind-powered membrane system for brackish water desalination*. *Renewable Energy*, 2013. 50: p. 126–135.
- [105] Peñate, B. and L. García-Rodríguez, *Current trends and future prospects in the design of seawater reverse osmosis desalination technology*. *Desalination*, 2012. 284: p. 1–8.
- [106] Likhachev, D.S. and F.-C. Li, *Large-scale water desalination methods: a review and new perspectives*. *Desalination and Water Treatment*, 2013. 51(13–15): p. 2836–2849.
- [107] Alkhudhiri, A., N. Darwish, and N. Hilal, *Membrane distillation: a comprehensive review*. *Desalination*, 2012. 287: p. 2–18.
- [108] Tzen, E., et al., *Design and development of a hybrid autonomous system for seawater desalination*. *Desalination*, 2004. 166: p. 267–274.
- [109] Tzen, E., D. Theofiloyianakos, and Z. Kologios, *Autonomous reverse osmosis units driven by RE sources experiences and lessons learned*. *Desalination*, 2008. 221(1–3): p. 29–36.
- [110] Vick, B.D. and R.N. Clark, *Experimental investigation of solar powered diaphragm and helical pumps*. *Solar Energy*, 2011. 85(5): p. 945–954.
- [111] Protogeropoulos, C. and S. Pearce, *Laboratory evaluation and system sizing charts for a 'second generation' direct PV-powered, low cost submersible solar pump*. *Solar Energy*, 2000. 68(5): p. 453–474.
- [112] Adiga, M.R., et al., *Performance analysis of photovoltaic electro dialysis desalination plant at Tanote in Thar desert*. *Desalination*, 1987. 67: p. 59–66.
- [113] Abraham, T. and A. Luthra, *Socio-economic & technical assessment of photovoltaic powered membrane desalination processes for India*. *Desalination*, 2011. 268(1–3): p. 238–248.
- [114] Li, C.N., Y. Goswami, and E. Stefanakos, *Solar assisted sea water desalination: a review*. *Renewable & Sustainable Energy Reviews*, 2013. 19: p. 136–163.

INTECH